

CHAMBERLAIN®

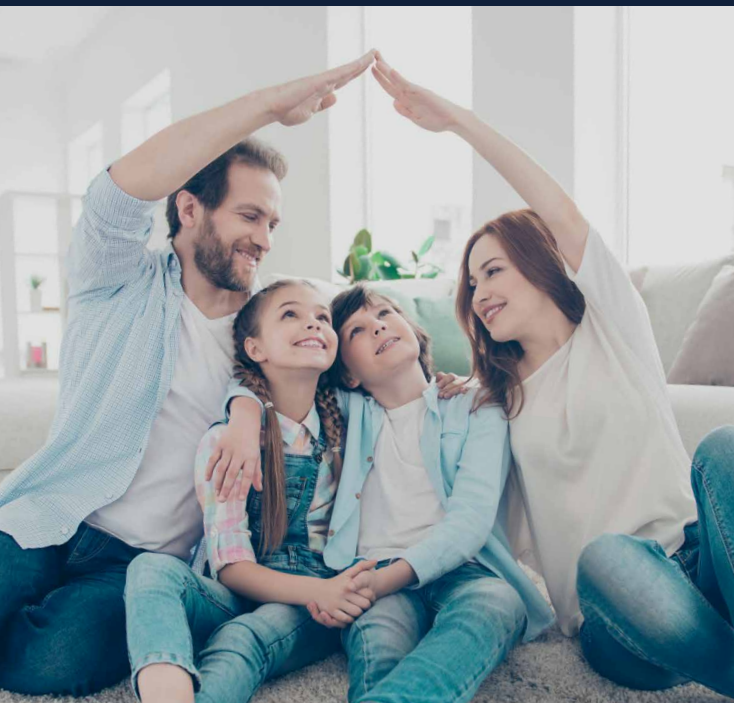

Product Catalogue

GARAGE DOOR OPENERS AND GATE OPERATORS

TUBULAR MOTORS

GARAGE DOOR OPENER AND GATE OPERATOR ACCESSORIES

TUBULAR MOTOR ACCESSORIES

CHAMBERLAIN GROUP

Everything we do is
about your home!

Chamberlain Group Global Headquarters, Oak Brook, Illinois



WE BRING MORE COMFORT AND SECURITY TO YOUR HOME – WITH PRODUCTS THAT SUIT YOUR FAMILY’S LIFESTYLE AND NEEDS.

At Chamberlain, you take centre stage. Everything we do is intended to help make your life easier, more secure and more convenient. Our products have been designed to seamlessly integrate into your home.

Decades of success confirm that our innovative products meet the highest quality demands and deliver satisfaction to millions of customers worldwide each and every day.



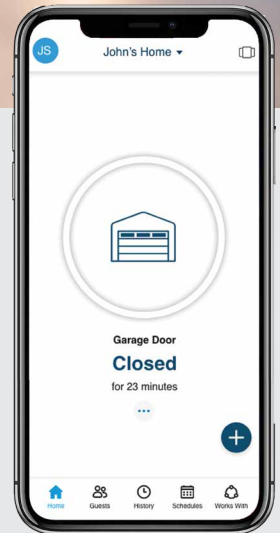
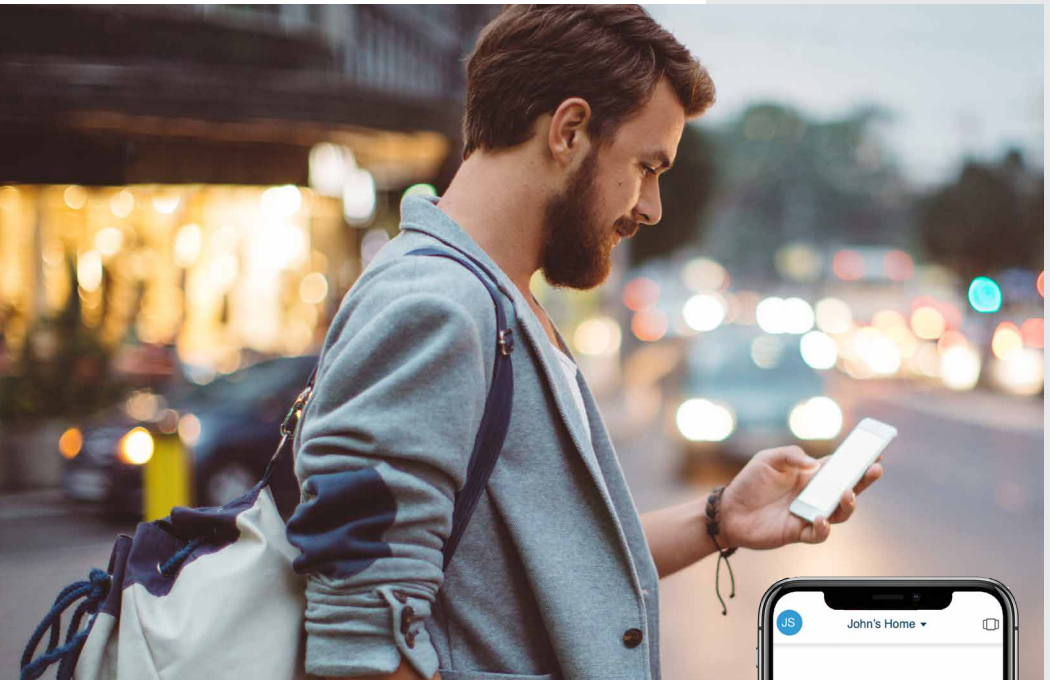

Complete control with just one tap.

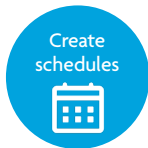

Control from anywhere.

With smart myQ technology, you have quick and easy access to your garage or driveway gate at all times. Use the free myQ app to explore many functions especially developed to increase your comfort.

- Complete control wherever you are
- Check if your garage door or driveway gate is open or closed
- Conveniently close or open your garage door or driveway gate with your smartphone
- Receive notifications as soon as the gate status changes

Guests and co-owners.

myQ users can add up to five trustworthy people as guests and grant them restricted access to the garage or property. The co-owner function grants two further people, e.g. family members, complete access rights for unrestricted use.

The smart solution for your garage and your driveway gate.

With myQ-capable gate and garage door openers, homeowners now have intelligent and smart control of their garages and driveway gates. This innovative technology not only increases convenience but also access security.



What myQ® can do.

myQ is the innovative solution to protect your home even when you're away.

- Sends notifications in real time as soon as the garage or driveway gate is opened or closed
- Practical creation of schedules for opening and closing gates or turning myQ LED light on and off

Complete control over all devices.

- The app shows the main user and co-owners activity logs
- Lets you set up new notifications for all myQ device activities
- Co-owners can edit existing schedules or create new schedules
- All activities are documented



myQ Starter Kit
(830REV-01)*

*see page 15 for more information about the myQ Starter Kit

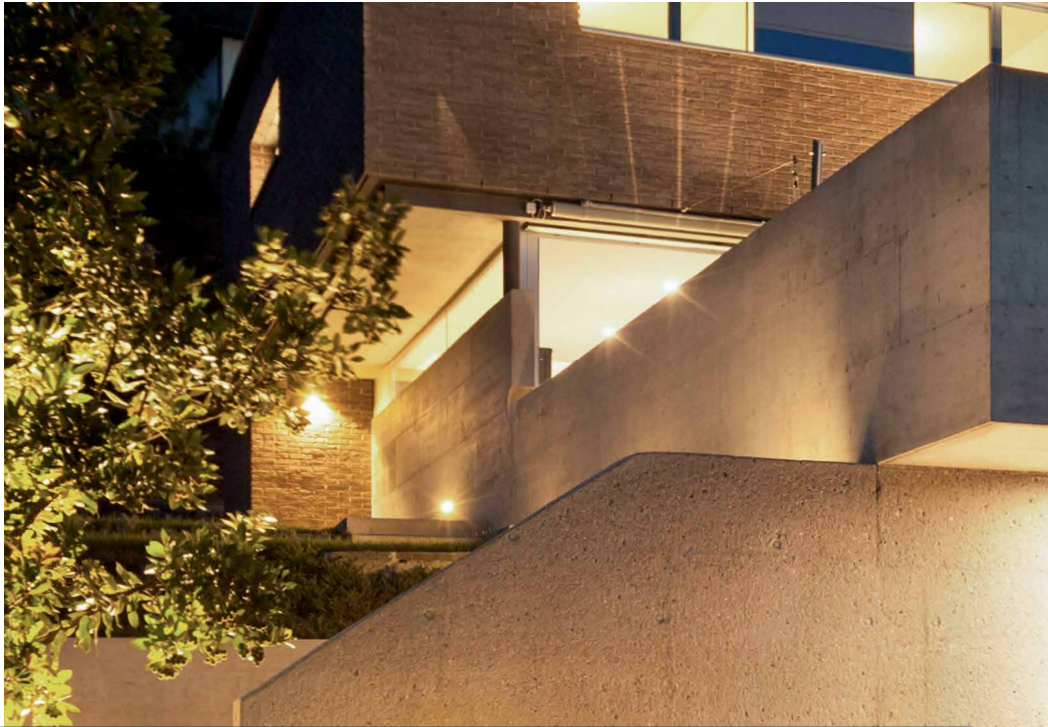

CHAMBERLAIN

Garage door openers

WELCOME HOME.

From powerful and quiet to secure and reliable - it's simple to find the right garage door opener to meet your individual needs and suit you. Explore Chamberlain garage door openers with innovative myQ technology and ultra-quiet toothed belt drives.



All of our openers are equipped with quiet and almost maintenance-free toothed belt drives.

ML580EV

! OUR ENTRY – LEVEL MODEL FOR STANDARD GARAGE DOORS



GARAGE DOOR TYPES

Sectional door



Up & Over retractable door with horizontal guides.



Non-protruding Up & Over with vertical & horizontal guides, and Up & Over canopy door with vertical guides.



Suitable for:



* A 1703REV-01 door arm has to be installed in order to automate non-protruding and canopy door.



PRACTICAL

Smart operation

The myQ Starter Kit (830REV-01) can be added at any time (excluding the ML580EV model).

MAX. LIFTING POWER	550N
STAND-BY CONSUMPTION	0.8W
MOTOR TYPE	24V DC
MAX. DOOR HEIGHT	2.125m
MAX. SPEED	100mm/s
MAX. DOOR AREA	7.4m ²
MAX. DOOR WIDTH	3.5m
MAX. DOOR WEIGHT	80kg
MOTOR WEIGHT	10kg
MOTOR GUARANTEE	4 years
TOTAL MOTOR LENGTH	3.15m
MYQ 'SMART' COMPATIBILITY	NO



ML580EV

Delivery includes:

- Tx 4-channel handheld transmitter
- Tx 3-piece steel track



ML810EV

! INCREDIBLY SMOOTH RUNNING,
VERY ECONOMICAL, SMARTPHONE
CONTROL POSSIBLE



Suitable for:



ML1040EV

! OUR MOST POWERFUL OPENERS
FOR LARGE DOORS, SMARTPHONE
CONTROL POSSIBLE



Suitable for:



800N

0.8W

24V DC

2.25m / 3.0m (with extension set 810CR5-02)

200mm/s

11.5m²

5.0m

110kg

12kg

6 years

3.20m

YES

1000N

0.8W

24V DC

2.25m / 3.0m (with extension set 810CR5-02)

200mm/s

13.5m²

5.5m

140kg

12kg

8 years

3.20m

YES

ML810EV

Delivery includes:

- 2x 4-channel handheld transmitter
- 1x 2-channel wireless remote control wall switch (128REV-01)
- 1x 3-piece steel track



ML1040EV

Delivery includes:

- 2x 4-channel handheld transmitter
- 1 x infrared photo beam (771REV-01)
- 1x 3-piece steel track



SMART ALL-IN-ONE PACKAGES!

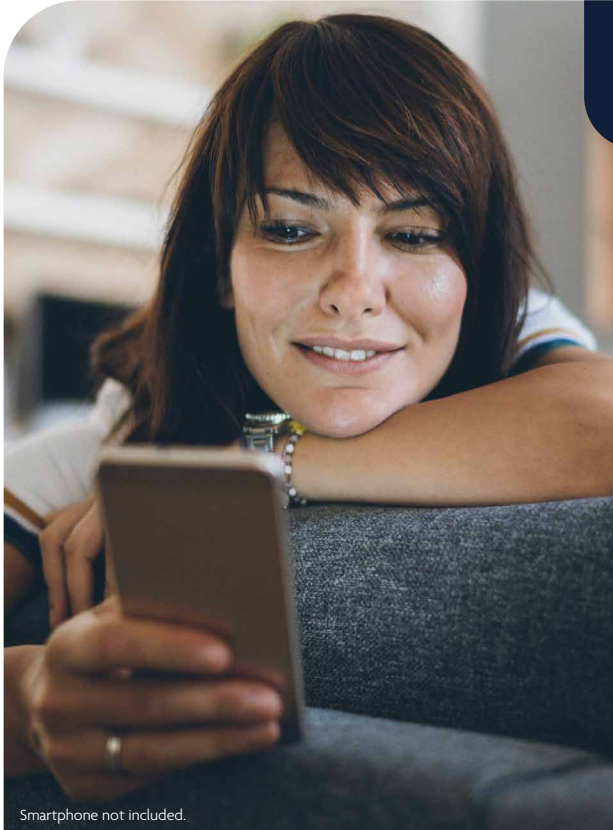

Smartphone not included.

MAX. LIFTING POWER
STAND-BY CONSUMPTION
MOTOR TYPE
MAX. DOOR HEIGHT
MAX. SPEED
MAX. DOOR AREA
MAX. DOOR WIDTH
MAX. DOOR WEIGHT
MOTOR WEIGHT
MOTOR GUARANTEE
TOTAL MOTOR LENGTH
MYQ 'SMART' COMPATIBILITY



PRACTICAL! Our motors are suitable for all standard doors from leading garage door manufacturers.

With myQ-enabled operators, you now have intelligent and smart control. This innovative technology not only increases convenience but also access security.

ML810EV-SMART

! INCREDIBLY SMOOTH, VERY ECONOMICAL
SMARTPHONE CONTROLS INCLUDED



Suitable for:



ML1040EV-SMART

! OUR MOST POWERFUL OPENER FOR LARGE DOORS
SMARTPHONE CONTROLS INCLUDED



Suitable for:

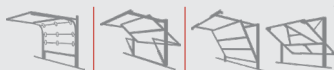

800N

0.8W

24V DC

2.25m / 3.0m (with extension set 810CR5-02)

200mm/s

11.5m²

5.0m

110kg

12kg

6 years

3.20m

YES

1000N

0.8W

24V DC

2.25m / 3.0m (with extension set 810CR5-02)

200mm/s

13.5m²

5.5m

140kg

12kg

8 years

3.20m

YES

ML810EV-SMART

Delivery includes:

2x 4-channel handheld transmitter
1x myQ Starter Kit (830REV-01)
1x 3-piece steel track



ML1040EV-SMART

Delivery includes:

2x 4-channel handheld transmitter
1x myQ Starter Kit (830REV-01)
1x 3-piece steel track



Garage door opener accessories



4-CHANNEL UNIVERSAL HANDHELD TRANSMITTER TX4RUNI-01

Features high-performance wireless technology with long range. Can be used to operate up to four garage door openers and gate operators.

- Also compatible with older Chamberlain motors with a signal frequency of 433MHz dating back to 1997
- Includes 3V battery CR2032



ILLUMINATED WALL SWITCH 75REV-01

Wired wall switch with LED light for mounting in the garage.

- Includes mounting material
- 69 x 26 x 19 mm



PRACTICAL

For quick and easy opening or closing of your garage door from inside the garage without a handheld transmitter.



WIRELESS KEYPAD 747REV-01

The garage door is operated by entering a 4-digit numerical code, simple, wireless installation. Up to 10,000 combinations possible and can be changed at any time. Temporary access code can be set up for visitors and staff, which can be restricted to a certain number of hours or openings.

- Illuminated buttons
- Suitable for multiple garage doors
- Rolling code
- Includes 9V block battery
- Dimensions 55 x 165 x 20 mm



KEY SWITCH 41REV-01

Opens and closes the door without a remote; suitable for wall mounting.

- 75 x 75 x 50 mm
- Includes 2 keys



2-CHANNEL WIRELESS REMOTE CONTROL WALL SWITCH 128REV-01

For wireless installation inside your garage.

- Elegant design
- 2 channels available for operating 2 garage doors
- Easy to mount onto the wall
- Includes 3V battery CR2032



PRACTICAL

No laying cables, fast and easy operation of the garage door from the garage without a handheld transmitter.



CANOPY DOOR ARM 1703REV

Robust and stable door arm for use with 1-piece horizontally or vertically tracked Up & Over doors.

- Completely opens the door
- Pre-installed with anti-crushing safety equipment
- Easy installation
- Not suitable for ML580EV



INFRARED PHOTO BEAM 771REV-01

Photo beam for installation with the garage door or driveway gate. Recognises obstacles during closing to ensure increased safety.

- Temperature range: -40 °C +60 °C
- Power consumption: max. 20mA
- Includes indicator LED

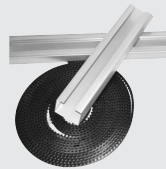

3m TRACK EXTENSION PACKAGE 810CR5-02

The track extension package lets you automate garage doors exceeding 2.25m in height (up to 3m). The track section supplied and the additional toothed belt are used to extend the travel distance.

Includes:

- Track extension piece
- Toothed belt

Garage door opener accessories



PRACTICAL! Essential for automated garage doors if there is no separate access door to the garage.



EXTERNAL EMERGENCY RELEASE 1702REV-01

For manual opening of the garage door from outside using a key if there is no lock or handle on the garage door.

- For opening from outside during a power cut
- 1.8m cable
- Anti-rust cover plate
- For doors up to 50mm in thickness
- Contains lock, fixing plate, clamps and 2 keys

Please note: For installation with garage doors without handles (e.g. sectional doors), a hole must be drilled into the door.

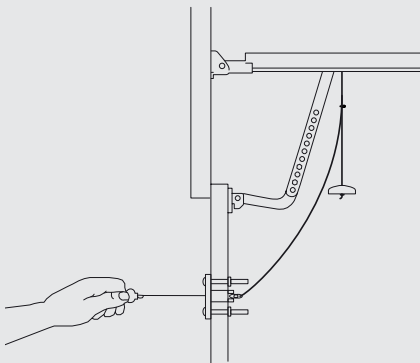

EMERGENCY RELEASE DOOR HANDLE 1REV-01

For manually opening your garage door with handle from outside via an additional lock. This emergency release can **ONLY** be used if the door has a handle. The steel cable is secured directly to the internal door handle. This then acts as a lever. The door handle is locked using the lock provided when not released.

- For opening from outside during a power cut
- 2.5m cable
- Operated via door handle and lock (no need to drill a hole)
- For garages without alternative access

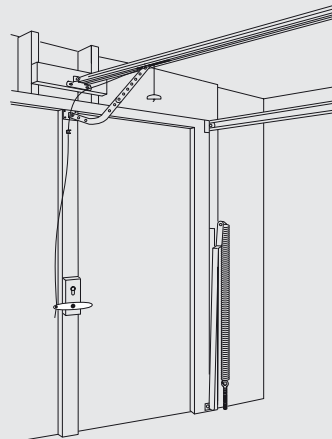

Make your garage door smart!



With the myQ Starter Kit by Chamberlain, you can easily update your Chamberlain garage door opener (apart from the ML580EV model) so you can control, monitor and check your garage door from anywhere in the world at all times with your smartphone or tablet.



PRACTICAL!

Classic or smart! The choice is yours!
Can be operated conveniently on site with a handheld transmitter or from any location via the free app.

myQ STARTER KIT 830REV-01

Connects the garage door opener to the internet via the router; this enables you to operate and monitor the door (recommended for sectional doors) from any location in the world. Light barrier (required) included.

Includes:

- Gateway
- LAN cable
- 230VAC/5VDC power adaptor with interchangeable plug
- Infrared photo beam 771REV-01



Our myQ® app.



Smartphone-controlled

Open and close your garage door or driveway gate from anywhere using your smartphone.



Guest access

Securely share access with up to five people.



Preset schedules

Specify when your door or gate should close.



Notifications in real time

Be informed when your garage door or driveway gate is opened or closed.

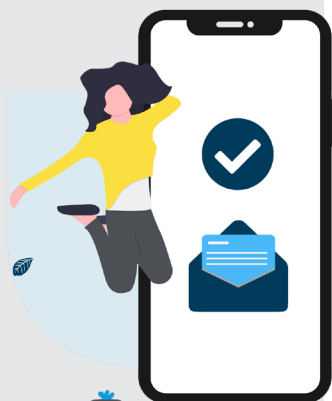



CHAMBERLAIN

Gate operators

WE OPEN THE DOOR TO MORE COMFORT AND SECURITY.

Whether you have a swing or a sliding gate, Chamberlain garage door openers and gate operators ensure reliable operation day in day out. Explore our gate operators with gentle start/stop operation.

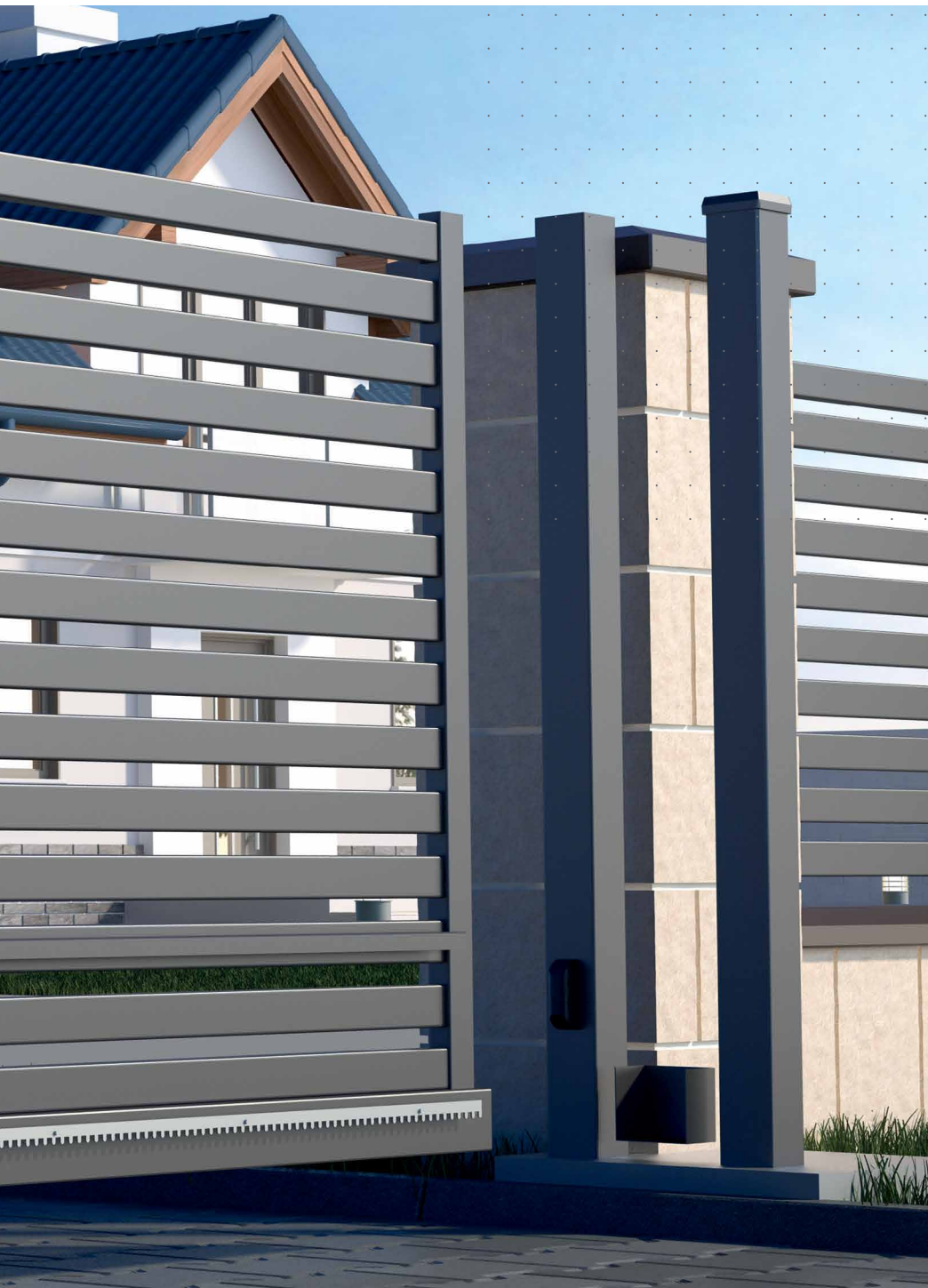

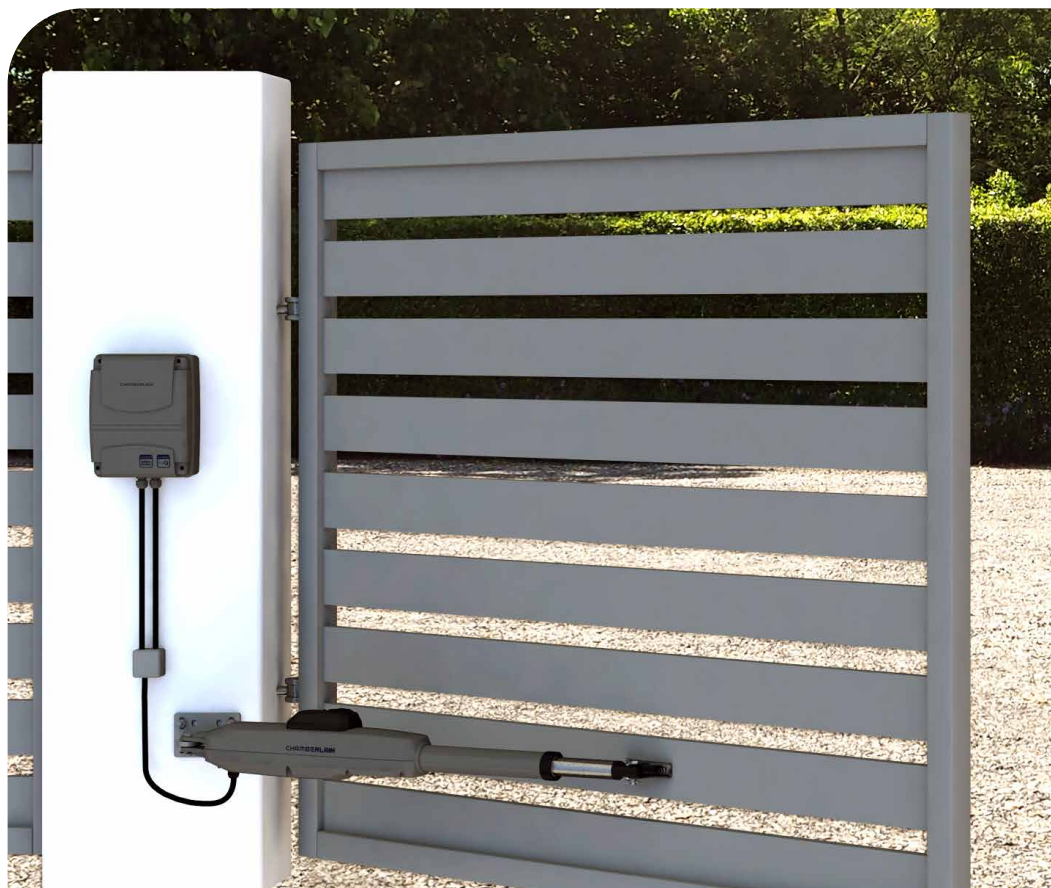

Chamberlain's myQ-capable gate operators give you more security when it comes to access to your property. Open and close your driveway gate the classic way at the touch of a button on the handheld transmitter or go the innovative route and use our free myQ app on your smartphone.

Whether you have a swing gate or sliding gate, we have the right operator for you.



CHLA250EVC SWING GATE OPERATOR



High-performance operator for single and double standard swing gates.

- Max. leaf width 2.5m
- Maximum leaf weight 200kg
- Smartphone control possible
- Automatic obstruction recognition
- Automation closing can be set up
- Soft start and soft stop function
- Manual emergency release possible
- Option to open just one leaf

Includes

- 2 motors and 1 control
- 2 design 4-channel handheld transmitter
- 1 infrared photo beam set
- 2 x 2 keys for emergency release
- Mounting material

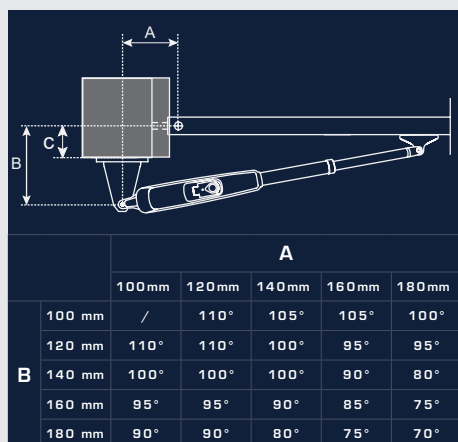

CHAA250EVC SWING GATE OPERATOR



Gate operator with articulated arms for single and double swing gates with wide posts.

- Maximum leaf width 2.5m
- Maximum leaf weight 200kg
- Smartphone control possible
- Automatic obstruction recognition
- Automation closing can be set up
- Soft start and soft stop function
- Manual emergency release possible
- Option to open just one leaf

Includes

- 2 motors, 2 articulated arms and 1 control
- 2 design 4-channel handheld transmitter
- 1 infrared photo beam set
- 2 x 2 keys for emergency release
- Mounting material

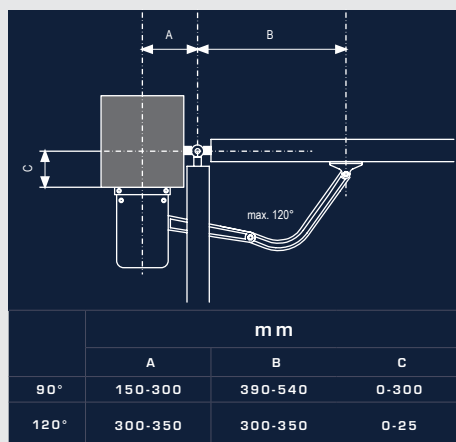



CHSL400EVC SLIDING GATE MOTOR



Gate operator kit for sliding gates up to max. 4m leaf width and/or 400kg leaf weight.

- Smartphone control possible
- Automatic obstruction recognition
- Automation closing can be set up
- Partial opening setting possible
- Emergency battery can be connected
- Soft start and soft stop
- Manual release possible
- Stand-by mode

Includes

- 1 motor with control
- 2 design 4-channel handheld transmitter
- 1 photo beam set
- 12 plastic toothed racks (0,33 m)
- 2 keys for emergency release
- 2 magnets for limit switch
- Mounting material

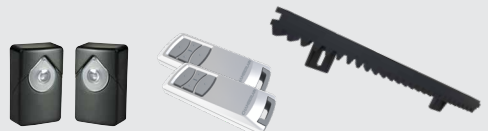

Gate operator accessories



PRACTICAL!

Make your driveway gate smart!



myQ STARTER KIT 830REV-01

Connects the gate operator via the router to the internet. Photo beam (required) included.



FLASHING SIGNAL LIGHTS FLA1-LED

Optical warning signal during gate operation for additional safety

- Light flashes during opening and closing
- 24V voltage
- Also suitable for ML810EV, ML1040EV, ML810EV-SMART, ML1040EV-SMART garage door openers



PHOTO BEAM 771REV-01

Photo beams for increased safety- the gate stops as soon as the sensor signal is blocked by an obstacle. The gate stops and re-opens on the closing cycle.

- Temperature range: -40 °C +60 °C
- Power consumption max. 20mA
- 2-cable system



4-CHANNEL UNIVERSAL HANDHELD TRANSMITTER TX4RUNI-01

Handheld transmitter with high-performance signal technology and long range. Up to four garage door openers and gate operators can be operated.



CHAMBERLAIN.

Roller shutter motors

LIGHT AT THE TOUCH OF A BUTTON.

Still opening and closing your roller shutters by hand?
Opt for the effortless, automated alternative!





Easily automate your roller shutters with corresponding motors by Chamberlain and find the right operating concept to suit you. Whether that's convenient remote control or our elegant wall switches. Intuitive to program and convenient to control.

Integral components are already installed to ensure fast, easy installation of all our roller shutter motors. The motor head and cable can withstand being rolled over, allowing installation in tight sites and preventing unwanted damage to slats or cables.

- Can be used with any standard roller shutters
- Easy installation thanks to detailed instructions
- Long service life
- Further adapter variations available
- Quiet motor

How do I find the right roller shutter motor?

1. Establish the external diameter of your roller shutter or awning shaft.
2. Establish the area of your roller shutters or awning
3. Consider the material of your roller shutters
4. If required, select suitable adaptors from our comprehensive range of accessories

IMPRESSIVE PERFORMANCE FEATURES



SIMPLE
Uncomplicated,
fast installation



EFFICIENT
Reduces the formation
of thermal bridges



ECONOMICAL
Less heat loss saves
on heating costs

Easy-to-install roller shutter motors!

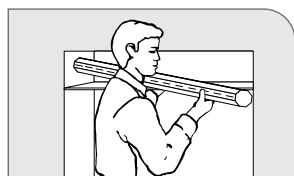
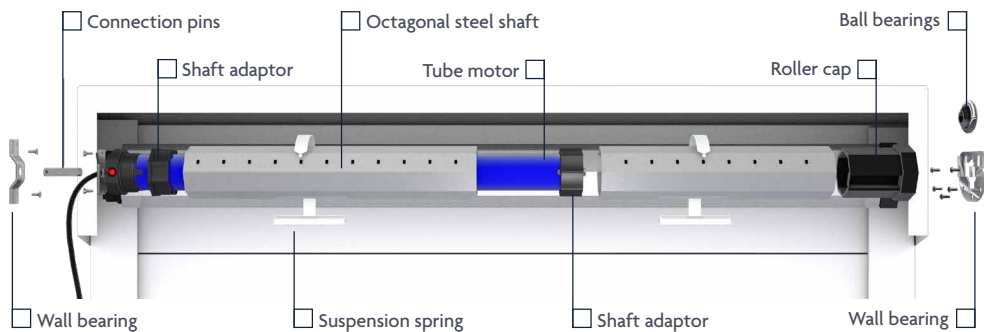

Remove the shaft

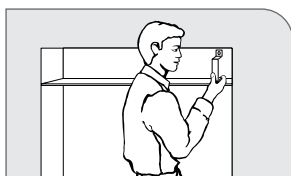

Secure the wall bearing

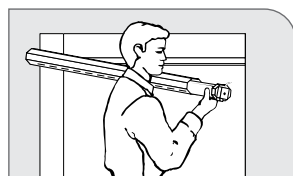

Install the motor

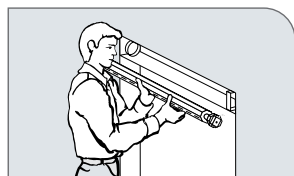

Secure the shaft at the wall bearing with the motor

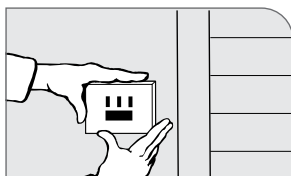

Install accessories (timer*, signal receiver)

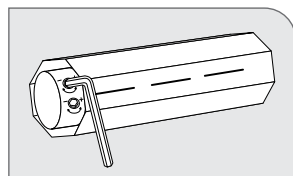

Set the start and stop points*

*Not necessary for remote-controlled roller shutters, which have electronic end points



SECURE

Makes it harder to open the shutters from outside



COMFORTABLE

No manual operation of roller shutters

STANDARD ROLLER SHUTTER MOTORS - WITHOUT REMOTE CONTROL



MODEL	RPD10-10	RPD15-10	RPD25-10	RPD40-10
TORQUE	10Nm	15Nm	25Nm	40Nm
END POSITION SETTING	MECHANICAL	MECHANICAL	MECHANICAL	MECHANICAL
REMOTE CONTROL	CAN BE RETROFITTED WITH A RRX1-10 SIGNAL RECEIVER			
OBSTRUCTION RECOGNITION	-	-	-	-
MAX. ROLLER SHUTTER WEIGHT	20kg	30kg	50kg	80kg
MOTOR HEAD/CABLE CAN BE ROLLED OVER	•	•	•	•
MAX. PVC ROLLER SHUTTER AREA	5 m ²	7.5 m ²	11 m ²	16 m ²
MAX. ALU ROLLER SHUTTER AREA	4 m ²	6 m ²	9 m ²	12 m ²
MAX. WOOD ROLLER SHUTTER AREA	2 m ²	3 m ²	5 m ²	7 m ²
MAX. AWNING AREA	-	-	-	20 m ²
OCTAGONAL SHAFT DIAMETER	40 mm	60 mm	60 mm	60 mm
AWNING SHAFT DIAMETER	-	-	-	78 mm
TUBE DIAMETER (MOTOR)	35 mm	45 mm	45 mm	45 mm
FEATURES	MECHANICAL END POINTS			MECHANICAL END POINTS / SUITABLE FOR AWNINGS

Includes

- CHAMBERLAIN roller shutter motor
- Adapter for octagonal steel shaft (40mm for RPD10-10, 60mm for RPD15-10, RPD25-10, RPD40-10)
- Adapter for 78mm awning shaft (RPD40-10)
- Adjustment pin to set end points for open and closed
- Detailed instructions
- Mounting material
- Wall bearing

REMOTE-CONTROLLED ROLLER SHUTTER MOTORS



PRACTICAL!

Easy to install thanks to electronic end points and remote control.

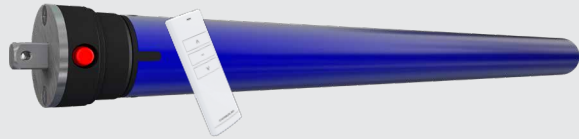

MODEL	RPD10ER-10	RPD15ER-10	RPD25ER-10	RPD40ER-10
TORQUE	10Nm	15Nm	25Nm	40Nm
END POSITION SETTING	ELECTRONIC	ELECTRONIC	ELECTRONIC	ELECTRONIC
REMOTE CONTROL	•	•	•	•*
OBSTRUCTION RECOGNITION	•	•	•	•
MAX. ROLLER SHUTTER WEIGHT	20kg	30kg	50kg	80kg
MOTOR HEAD/CABLE CAN BE ROLLED OVER	•	•	•	•
MAX. PVC ROLLER SHUTTER AREA	5 m ²	7.5 m ²	11 m ²	16 m ²
MAX. ALU ROLLER SHUTTER AREA	4 m ²	6m ²	9 m ²	12 m ²
MAX. WOOD ROLLER SHUTTER AREA	2 m ²	3 m ²	5 m ²	7 m ²
MAX. AWNING AREA	-	-	-	20 m ²
OCTAGONAL SHAFT DIAMETER	40 mm	60 mm	60 mm	60 mm
AWNING SHAFT DIAMETER	-	-	-	78 mm
TUBE DIAMETER (MOTOR)	35 mm	45 mm	45 mm	45 mm
FEATURES	REMOTE CONTROL, OBSTRUCTION RECOGNITION, ELECTRONIC END POINTS			

* (Obstruction recognition not possible when used for awnings)

Includes

- CHAMBERLAIN roller shutter motor
- 1-channel remote control with wall holder
- Adapter for octagonal steel shaft (40mm for RPD10ER-10, 60mm for RPD15ER-10, RPD25ER-10, RPD40ER-10)
- Adapter for 78mm awning shaft (RPD40ER-10)
- Wall bearing
- Detailed instructions
- Mounting material

Accessories for roller shutters without remote control



WALL SWITCH TCSIED-10

For flush interior mounting. This wall switch is connected directly to the roller shutter motor. Suitable for all roller shutters without remote control.



BASIC TIMER SWITCH TIEML-05

Conveniently control your roller shutters via a user-friendly menu. Suitable for all roller shutters without remote control.



SURFACE-MOUNTED TOGGLE SWITCH RZ94-05

Comfortable control of your roller shutter motor. For surface mounting. White switch with rotator featuring a test and lock function. Suitable for all roller shutters without remote control.



COMFORT TIMER SWITCH T3EML-05

Simple programming and easy changes to set times thanks to an easily understandable menu. Opening and closing times can be programmed for days in advance. Suitable for all roller shutters without remote control. It's possible to connect a sun sensor.



PRACTICAL!

Automatic time controls and the Basic and Comfort timer switchers with random program for holidays provide additional security.



PRACTICAL!

Automatic protection from sun

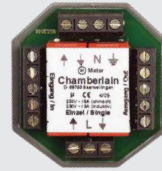
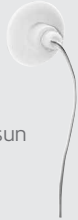

SUN SENSOR
LS3EML-05

Opens and closes your roller shutters automatically depending on the sun in combination with the COMFORT (T3EML-05) timer switch.

ISOLATING RELAY
WTMZ1-05

Facilitates central control of multiple roller shutter motors. A relay is required for each connected motor. Not necessary for remote controlled roller shutter motors.



Accessories for remote-controlled roller shutter motors



1-CHANNEL REMOTE CONTROL WALL SWITCH RTXW1-10

Chamberlain 1-channel remote control wall switch in an attractive, modern design for Chamberlain's roller shutter motors. Chamberlain's 1-channel remote control wall switch lets you conveniently operate roller shutters without any manual effort.

- Compatible with the RPD10ER-10, RPD15ER-10, RPD25ER-10 and RPD40ER-10 remote controlled roller shutter motors
- Operates one set of roller shutters on each channel or any amount of roller shutters on one channel for simultaneous use
- Operation is via the 'up', 'down' and 'stop' buttons
- Can be added to all standard roller shutter motors with mechanical end points in conjunction with the RRX1-10 signal receiver



PRACTICAL!

A 1-channel or 2-channel remote control wall switch can be programmed and operated in addition to the 1-channel or 8-channel handheld transmitter.



2-CHANNEL REMOTE CONTROL WALL SWITCH RTXW2-10

Modern 2-channel remote control wall switch for Chamberlain remote controlled roller shutter motors RPD10ER-10, RPD15ER-10, RPD25ER-10 and RPD40ER-10.

Programming options:

- One roller shutter on each channel
- As many roller shutters as required on one channel for simultaneous operation

Operation is via the 'up', 'down' and 'stop' buttons. Can be added to all standard roller shutter motors with mechanical end points in conjunction with the RRX1-10 signal receiver.

EXTERNAL SIGNAL RECEIVER



RRX1-10





**1-CHANNEL HANDHELD TRANSMITTER
RTX1P-10**

1-channel handheld transmitter in an attractive, modern design for Chamberlain's remote controlled roller shutter motors.

With the Chamberlain 1-channel handheld transmitter, your roller shutters can be easily controlled from the couch.

- Compatible with the RPD10ER-10, RPD15ER-10, RPD25ER-10 and RPD40ER-10 remote controlled roller shutter motors
- Can be added to all standard roller shutter motors with mechanical end points in conjunction with the RRX1-10 signal receiver
- Operates one set of roller shutters on each channel or any amount of roller shutters on one channel for simultaneous use
- Operation is via the 'up', 'down' and 'stop' buttons



**8-CHANNEL HANDHELD TRANSMITTER
RTX8P-10**

The 8-channel remote control features a modern design and is compatible with Chamberlain remote controlled roller shutter motors RPD10ER-10, RPD15ER-10, RPD25ER-10 and RPD40ER-10.

Can be added to all standard roller shutter motors with mechanical end points (in conjunction with the RRX1-10 signal receiver)

Programming options:

- Eight different roller shutters on eight channels
- A group on one channel and individual roller shutters on further channels
- As many roller shutters as required on one channel for simultaneous operation (within the reach)

All standard roller shutter motors with mechanical endpoints (including roller shutters from other brands) can be retrofitted to include a remote control system with the RRX1-10 external signal receiver by Chamberlain.

- Only Chamberlain handheld transmitters and accessories are compatible with the Chamberlain signal receiver

- The signal receiver is installed in the roller shutter housing directly adjacent to the motor
- The wall switch or timer switch must be uninstalled at the time of installation of the signal receiver The RTXW1-10 1-channel remote control wall switch or the RTXW2-10 2-channel remote control wall switch from Chamberlain's accessory range can be installed at any location.

Mechanical roller shutter accessories

Chamberlain offers you a comprehensive program of mechanical roller shutter accessories.

Consider whether you are using the MAXI or MINI roller shutter system.

The roller shutter system can be checked using the width of the shutter belt and the height of the slats (see graphic).



1. Octagonal steel shaft
2. Belt disc
3. Roller cap
4. Ball bearing
5. Bearing insert
6. Roller shutter slats
7. Suspension spring
8. Roller shutter stopper
9. Belt channel
10. Wall box
11. Input belt winder
12. Cover
13. Output belt winder
14. Belt

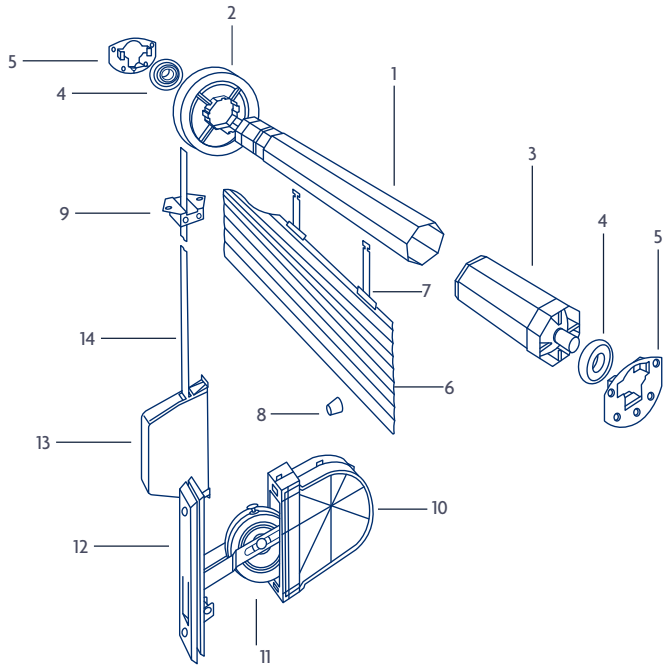

1. Octagonal shafts

- For winding the shutter slats up and down
- Available in different lengths for both roller shutter systems
- MAXI shaft diameter 60mm - MINI shaft diameter 40mm
- A telescopic shaft for the roller shutter system allows variable shaft extension up to 40cm

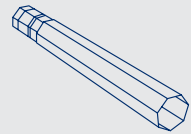

	maxi	mini	LENGTH	DIAMETER
RZ04-01	•		1.0m	60mm
RZ06-01	•		2.0m	60mm
RZ08-01	•		3.0m	60mm
RZ09-01 *	•		0.5m	60mm
RZ10-01		•	2.0m	40mm
RZ67-01		•	1.5m	40mm

*Seamless extension piece for insertion into an octagonal steel shaft

2. Belt disc

- For winding the roller shutter belt in the shutter housing
- Adjustability: belt discs can be slid over the roller shutter shaft



	maxi	mini	BELT DISC	DIAMETER
RZ97-01		•	ADJUSTABLE	100mm
RZ18-01	•		ADJUSTABLE	170mm
RZ19-01	•		ADJUSTABLE	190mm
RZ20-01	•		ADJUSTABLE	210mm

3. Roller cap

- Connect the steel shaft to the ball bearing
- Allows wiggle room of up to 8cm when installing the shaft
- Available for MAXI and MINI roller shutter systems

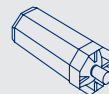

	maxi	mini	LENGTH	DIAMETER
RZ55-01	•		90mm	60mm
RZ56-01	•		165mm	60mm
RZ57-01		•	100mm	40mm

For octagonal steel shaft

4. Ball bearing / 5. Bearing insert

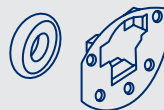

- To secure the steel shaft in the roller shutter housing
- Durable and robust
- Easy installation

	maxi	mini	FEATURE
RZ28-01	•		MAXI BALL BEARING
RZ29-01	•		MAXI BEARING INSERT, ZINC-PLATED
RZ98-01	•		MAXI WALL BEARING, COMPLETE *
RZ66-01		•	MINI WALL BEARING, COMPLETE *

*consisting of bearing plate and ball bearings

6. Roller shutter slats

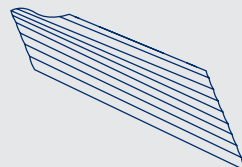

- Available in MAXI and MINI (slat height 55mm / 37mm)
- Includes locking device to avoid side slippage

	maxi	mini	FEATURE	LENGTH
RZ59-01	•		PVC, GREY, WITH LOCKING DEVICE	150cm
RZ60-01	•			180cm
RZ61-01		•		120cm
RZ62-01		•		150cm

7. Suspension springs and anti-lift device

- Suspension springs to secure the shutter housing to the octagonal shaft
- Available in MAXI and MINI
- Suitable for mechanical and electrical roller shutters
- Universal and easy to use; simple assembly with instructions



	maxi	mini	FEATURE	QUANTITY
RZ41-01	•		MOUNTS	3 PIECES
RZ42-01		•	MOUNTS	3 PIECES
RZ51-01	•	•	SECURING CLAMP FOR MECHANICAL CLAMPING	2 PIECES

8. Roller shutter stopper

- Prevents excess intake of the roller shutter into the housing
- Easy installation on the bottom roller shutter slat or end bar



	FEATURE	COLOUR	QUANTITY
RZ53-01	ROLLER SHUTTER STOPPER	BEIGE	2 PIECES
RZ54-01	ROLLER SHUTTER STOPPER	GREY	2 PIECES
RZ92-01	BRACKET	GREY	2 PIECES

9. Belt channel and guide rollers

- Belt channels with a high level of comfort thanks to integrated brushes for draught insulation
- Available in MAXI and MINI
- Easy installation with two screws



	maxi	mini	FEATURE	COLOUR
RZ11-01	•		DOUBLE GUIDE ROLLER	METAL
RZ13-01	•		'VERTICAL' BELT CHANNEL WITH BRUSH	WHITE
RZ14-01	•		'HORIZONTAL' BELT CHANNEL WITH BRUSH	WHITE
RZ15-01	•		'ROUND' BELT CHANNEL WITH BRUSH	WHITE
RZ12-01		•	DOUBLE GUIDE ROLLER, METAL	METAL
RZ16-01		•	'VERTICAL' BELT CHANNEL WITH BRUSH	WHITE

10. Wall boxes

- For flush mounting of the MAXI roller shutter system
- Available for various distances between holes

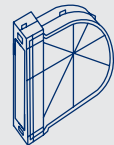

	MATERIAL	BELT LENGTH	DISTANCE BETWEEN HOLES
RZ33-01	PLASTIC	up to 5m	135mm
RZ31-01	PLASTIC	up to 8m	165mm
RZ34-01	PLASTIC	up to 12m	185mm

Roller shutter motor accessories



PLEASE NOTE!

Wall boxes, belt winders and cover plates are available for various distances between holes. Ensure you have the right distance between holes when purchasing.

11. Input belt winder

- MINI belt winder complete with wall boxes, cover plate and 5m belt
- Available for the MAXI roller shutter system and for various distances between holes
- For flush mounting

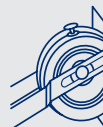

	maxi	mini	BELT WINDER	BELT LENGTH	DISTANCE BETWEEN HOLES
RZ22-01	•		ZINC-PLATED	up to 3m	135mm
RZ24-01	•		ZINC-PLATED	up to 5m	165mm
RZ25-01	•		ZINC-PLATED	up to 8m	165mm
RZ21-01	•		ZINC-PLATED	up to 12m	185mm
RZ99-01	•		ZINC-PLATED	up to 12m	215mm
RZ26-01		•	READY TO INSTALL	up to 5m	130mm

12. Cover plates for belt winder inputs

- Available for various distances between holes
- For covering belt winder inputs



	COLOUR	DISTANCE BETWEEN HOLES
RZ90-01	WHITE	105mm
RZ91-01	WHITE, FOR REPAIRS WITHOUT REMOVING THE BELT	135mm / 165mm
RZ01-01	WHITE	135mm
RZ02-01	WHITE	165mm
RZ03-01	WHITE	185mm
RZ100-01	WHITE	215mm

13. Output belt winder

- For surface mounting, can be rotated by 180°
- With 5m roller shutter belt
- MAXI and MINI designs



	maxi	mini	ROTATABLE	COLOUR	BELT LENGTH
RZ23-01	•		•	WHITE	up to 5m
RZ27-01		•	•	WHITE	up to 5m

14. Repair kits and belts

Repair kits

- Repair kits with assembly instructions
- Repairing damaged roller shutter belts without opening the housing
- Available in MAXI and MINI, with and without belt

	maxi	mini	COLOUR	INCLUDES ROLLER SHUTTER BELT
RZ36-01	•			WITHOUT BELT
RZ38-01	•		GREY	5m
RZ88-01	•		BEIGE	5m
RZ35-01		•		WITHOUT BELT
RZ39-01		•	GREY	5m
RZ89-01		•	BEIGE	5m

Belts

- Roller shutter belts in various colours and lengths for MAXI (belt width 23mm) and MINI (belt width 14mm) roller shutter systems
- High-quality weave with reinforced edges

	maxi	mini	COLOUR	ROLLER SHUTTER BELT LENGTH
RZ45-01	•		GREY	6m
RZ46-01	•		WHITE	6m
RZ85-01	•		BEIGE	6m
RZ49-01		•	GREY	6m
RZ50-01		•	WHITE	6m
RZ87-01		•	BEIGE	6m
RZ43-01	•		GREY	12m
RZ44-01	•		WHITE	12m
RZ84-01	•		BEIGE	12m
RZ47-01		•	GREY	12m
RZ48-01		•	WHITE	12m
RZ86-01		•	BEIGE	12m

Roller shutter belt motors



SIMPLE
Uncomplicated,
fast installation

*Lightweight plastic slats

MODEL	
MOUNTING	
MAX. ROLLER SHUTTER AREA *	
MAX. ROLLER SHUTTER HEIGHT	
BELT WIDTH	
BELT WIDTH / MAX. BELT LENGTH	mini
	maxi
LIFTING POWER	
PERFORMANCE	
STAND-BY PERFORMANCE	
INCLUDES LCD DISPLAY	
INCLUDES SUN SENSOR	



Roller shutter belt motors

Chamberlain's electronic roller shutter motors stand out thanks to their performance and quiet operation:

- Ideal for quickly and simply exchanging a mechanical belt winder
- Easy to install in just a few steps
- Completely automatic controls open and close at programmed times
- Increases standard of living

WPD25U-05	WPD30U-05	WPD45UP-05	WPD60UP-05
SURFACE/FLUSH	SURFACE	FLUSH	FLUSH
8 m ²	8 m ²	10 m ²	10 m ²
2.20m	2.20m	2.20m	2.20m
14 - 23 mm	14 - 23 mm	23mm	23mm
1.0mm / 5.50m	1.3mm / 4.00m		
1.0mm / 5.50m 1.3mm / 4.50m	1.0mm/5.00m 1.3mm/4.00m 1.5mm/3.40m	1.0mm/7.60m 1.3mm/6.20m 1.5mm/5.20m	1.0mm/7.60m 1.3mm/6.20m 1.5mm/5.20m
25KG	30KG	45KG	45KG
30W	70W	100W	100W
1.35W	2W	2W	2W
-	-	-	•
•	•	-	-

Simple flush mounting (e.g. WPD60UP-05)

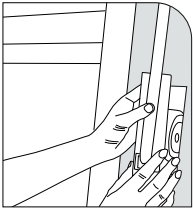

Remove mechanical winder

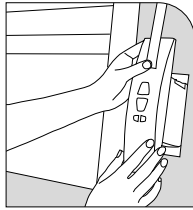

Install electrical belt motor

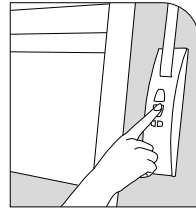

Connect - done!

Simple surface mounting (e.g. WPD30U-05)

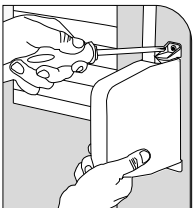

Remove mechanical belt motor

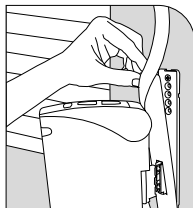

Insert belt and hook in

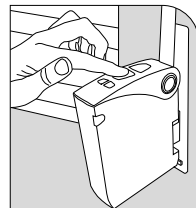

Connect - done!

Changes to the products are for the purpose of technological progress and remain reserved.

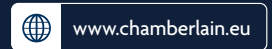
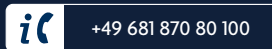

BDIYEN | July 2022

Service hotline

The App Store logo is a trademark of Apple Inc.
The Google Play logo is a trademark of Google LLC.
myQ® is a registered trademark of the Chamberlain Group
© 2021 The Chamberlain Group, Inc. all rights reserved

